



<b>EV-SCM2 (-EU) – Dual Output Sounder Control Module with PSU Fault input and Isolator</b>	<b>EN 54-17: 2005 / AC: 2007 – Short Circuit Isolators</b> <b>EN 54-18: 2005 / AC: 2007 – Input / Output Devices</b>
	<p><b>For use with Nittan Evolution Protocol Only.</b></p> <p><b>Loop Voltage: 20 to 38 Vdc</b>  <b>Quiescent Current: 740µA</b>  <b>Alarm Current: 3.1mA</b>  <b>Loop resistance: &lt; 50 ohm/ km</b>  <b>Output circuit resistance: &lt; 50 ohm/ km</b>  <b>EOL resistor: 10k ohm</b>  <b>External Power Supply: 20 to 30Vdc</b>  <b>Relay Contact rating: 1A at 30 Vdc</b>  <b>Min sw open voltage (Vso min): 11 Vdc</b>  <b>Max sw open voltage (Vso max): 14 Vdc</b>  <b>Min sw close voltage (Vsc min): 3 Vdc</b>  <b>Max sw close voltage (Vsc max): 10 Vdc</b>  <b>Max line current (Ic max): 500 mA</b>  <b>Max switching current (Is max): 1500 mA</b>  <b>Max leakage current (Il max): 15 mA</b>  <b>Max switch resistance (Zc max): 150 mΩ</b>  <b>Wire size: Min. 0.75mm<sup>2</sup></b>  <b>Max. 2.5mm<sup>2</sup></b>  <b>Operating temperature: -10°C to 55°C</b>  <b>Storage temperature: -40°C to 80°C</b>  <b>Max. relative humidity: 95%RH, non-condensing</b>  <b>Mass EV-SCM2: 145g</b>  <b>Mass EV-SCM2-EU: 130g</b></p> <p><b>Technical Data Sheet: TD-EV-SCM2 (-EU)</b></p>
<p><b>DoP Number: 00641</b></p>	
	<p>Nittan Europe Ltd. Tel: +44 (0) 1483 769 555          Hipley Street, Fax: +44 (0) 1483 756 686          Old Woking, Email: <a href="mailto:sales@nittan.co.uk">sales@nittan.co.uk</a>          Surrey, GU22 9LQ Web: <a href="http://www.nittan.co.uk">www.nittan.co.uk</a>          United Kingdom</p>

### RoHS Compliance Statement

This product complies with the European Union RoHS (Restriction of Hazardous Substances) directive 2011/65/EU which restricts the use of the following six hazardous materials in the manufacture of electronic and electrical equipment.

- Lead (Pb)
- Hexavalent Chromium
- Mercury (Hg)
- Cadmium (Cd)
- Polybrominated biphenyls (PBB's)
- Polybrominated diphenyl ethers (PBDE's)

**NOTE:** Please read these instructions carefully and keep for future reference. The information in this document is subject to change without notice. For updates please refer to our website.

**NOTE:** Follow the requirements for the installation of the product in accordance with the Specifications. Otherwise it may cause malfunction

**NOTE:** Do not install the product in any location where oil, dust, iron powder, chemicals, or hydrogen sulphide may occur or affect the product. It may cause malfunction.

### This package contains the following items:

Main unit: x 1  
 EOL resistor: 10k Ohm x 2  
 PSU FLT Resistor: 0 Ohm x 1 (Factory fitted to device)  
 Jumper: x 1  
 Allen Key x 1  
 Mounting Screws M3.5 x 25mm x 2 (EV-SCM2 Only)  
 Manual: (this document) x 1

### General Description

The EV-SCM2 (-EU) Sounder Control Module is an addressable output module with short circuit isolator. The EV-SCM2 uses UK 2-gang box with surface and flush mount options, and the EV-SCM2-EU uses European 503 electrical box flush-mounted.

The module provides two supervised outputs (Class B) to activate conventional alarm devices such as sounders, beacons, and bells, in response to a command signalled from a control panel.

The module has a periodic restart function to keep the synchronisation of alarm devices. This function is available with the DIP switch setting if the devices connected support that feature.

The alarm devices are powered from an EN 54-4 certified 24V external power supply. The module can detect voltage drop of power supply unit. Using the PSU fault output relays, connected in series, the module can monitor PSU fault.

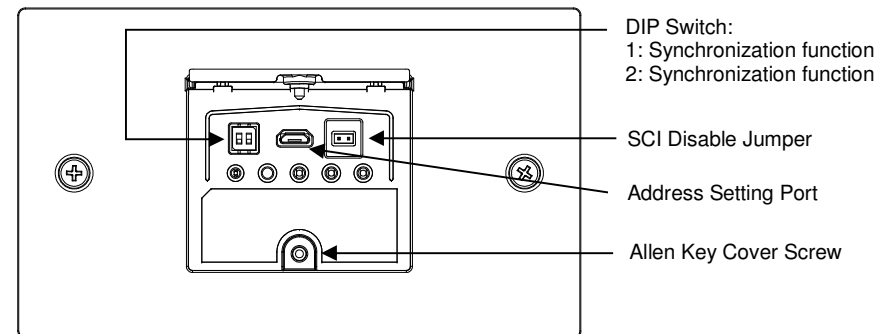

Figure 1

The EV-SCM2 (-EU) detects the state of sounder circuits: normal, output, open, short, and relay stuck. Those states and PSU fault/voltage drop are indicated by the LEDs on the module.

When a short circuit occurs in the sounder circuit, the relay is not activated and the alarm devices connected in the circuit do not operate, even if commanded to activate them by the control panel.

### Address Setting

Loosen the Allen key screw to open the access door in the front, using the 1.5mm Allen key provided. It is possible to configure the address setting and change the setting of DIP switch or jumper pin (refer to Figure 1).

Use EV-AD2-EXT to set the address of the EV-SCM2 (-EU). The factory default address of 1 is given to the module. Connect the EV-AD2-EXT to the address setting port with the Micro USB cable for the programmer, and change the address to any of 1-254, with reference to the instruction manual of EV-AD2-EXT programmer. (Note that the number of available addresses can be less depending on a control panel model.) The address can be set regardless of whether power supply from the control panel is turned on or off.

Address setting is possible even after connecting the module to the Loop.

### DIP Switch Operation

With the DIP switch 1, it is possible to enable/ disable the synchronization of alarm devices in the sounder circuit 1. The DIP switch 2 has a function to enable/disable the synchronization of alarm devices in the sounder circuit 2.

DIP switch	Position	Function
1	ON	Sounder Circuit 1: Disable synchronisation function by steady voltage
	OFF	Sounder Circuit 1: Enable synchronisation
2	ON	Sounder Circuit 2: Disable synchronisation function by steady voltage
	OFF	Sounder Circuit 2: Enable synchronisation

Table 1

### LED Operation

Four LEDs are visible through the translucent access door of the enclosure (refer to Figure 2 and Table 2).

Polling LED: flashes green during polling from the control panel.

Output LED: illuminates red when alarm devices are activated.

FAULT LED: illuminates yellow when a fault condition, i.e. an open or short circuit, relay stuck fault in the sounder circuit, or PSU/PSU low voltage fault is detected.

SCI LED: illuminates yellow when a short circuit is detected in the loop and the short circuit isolator (SCI) is activated.

### Dimensions

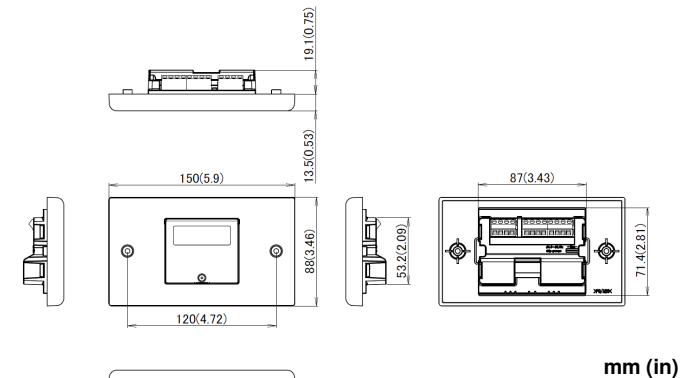

Figure 6 – EV-SCM2

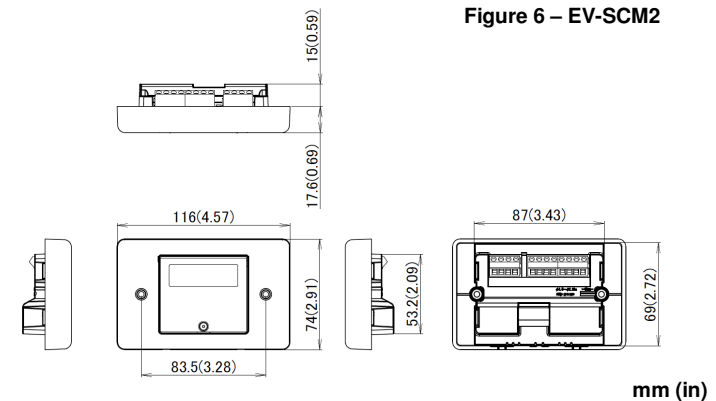

Figure 7 – EV-SCM2-EU

### End of Life Disposal

Like all electronic equipment, at the end of its working life this unit should not be disposed of in a refuse bin. All Nittan products since 2005 have been marked with the WEEE Logo in compliance with European Directive 2012/19/EU and Nittan Europe Limited is a member of a WEEE Compliance Scheme. Contact sales@nittan.co.uk for a copy of our WEEE Compliance Policy.



### Service and Maintenance

Inspection and tests of the module shall be carried out periodically according to the requirements of BS 5839 Part 1, Fire Detection and Alarm Systems for Buildings: Code of Practice for System Design, Installation and Servicing, or equivalent local codes of practice.

For a routine inspection, ensure the module is secure and undamaged.

When carrying out site testing of the module, set the Fire Alarm Control Panel to test mode and take any necessary precautions, so as to limit the activation of alarm sounders/bells and any fire service summoning device.

### Trouble shooting

Problem	Possible cause
No response	The module falls off. Address setting is not correct. Duplicate address. Loop wiring is not correct. An open/ short circuit in the loop. Loop voltage is too low.
Communication error	Duplicate address. Loop voltage is too low.
The module information is not found on the panel	Data registered on the control panel is not correct.
PSU fault	Wiring is not correct. The PSU is at fault.
PSU voltage drop	Wiring is not correct. The PSU is at fault.
Open circuit is detected in the sounder circuit	Incorrect sounder circuit wiring. EOL resistor is removed.
Short circuit is detected in the sounder circuit	Sounder circuit is shorted.
Relay stuck is detected	Relay is at fault. Relay is welded due to exceeding the rating.
Alarm devices do not operate	Incorrect sounder zone wiring. Relay is in fault.
Alarm devices operate continuously	Incorrect sounder zone wiring. Control panel has incorrect cause and effect programming. Address setting is not correct. Problem with alarm devices. Relay is at fault.
SCI operates	There is a short circuit in the loop. Too many devices (over 20mA in total in a standby condition) are connected between the module and the next SCI.

### Indicating LEDs

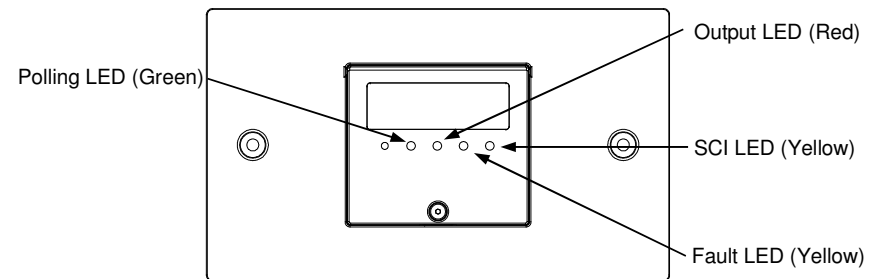

Figure 2

	Colour	Function	State of module	State of LED
<b>Polling LED</b>	Green	Polling	Polling	Flashing
<b>Output LED</b>	Red	Output	Relay on	Steady on
<b>Fault LED</b>	Yellow	Fault	Open/short/Relay stuck/PSU Fault/PSU Voltage drop	Steady on
<b>SCI LED</b>	Yellow	Loop	SCI	Steady on

Table 2

### Installation

The EV-SCM2 is designed to mount on the range of 2-Gang back boxes widely available in the UK (Min 35mm depth). Refer figure 3. The EV-SCM2-EU is designed to mount on the European 503 series back boxes available in many European countries. Refer figure 4.

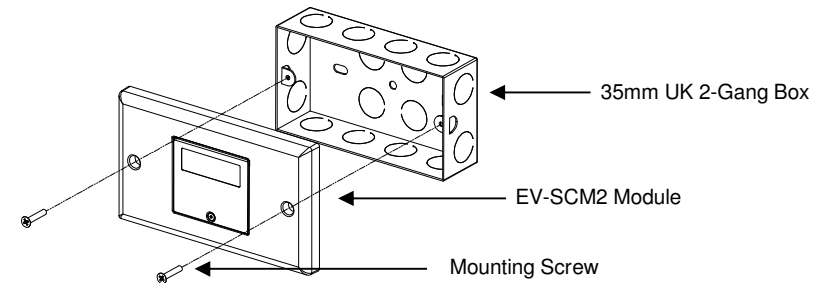

Figure 3 – EV-SCM2

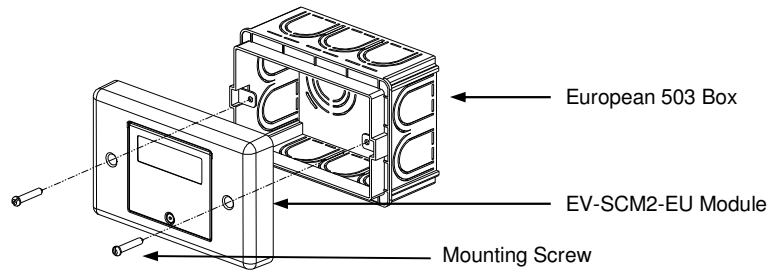

Figure 4 – EV-SCM2-EU

### Connections

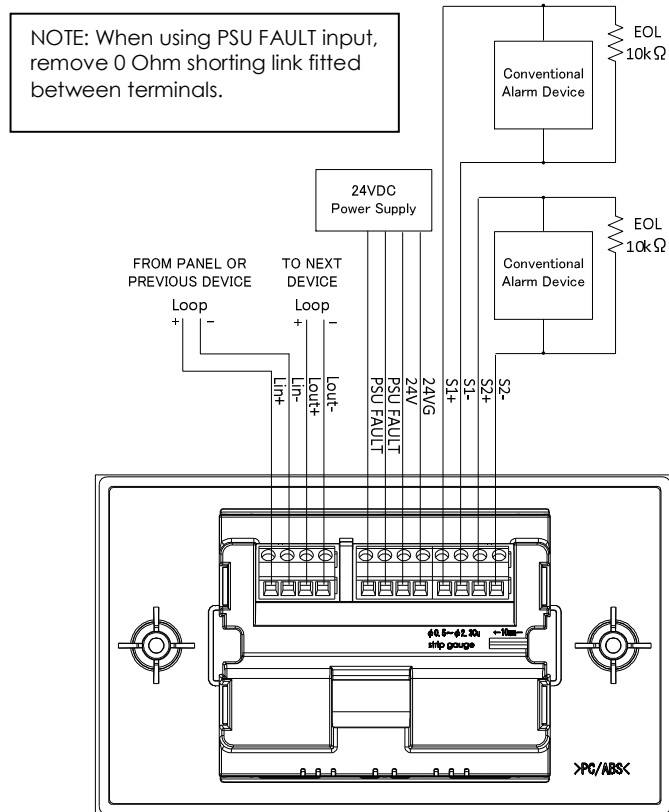

Figure 5

### General Operation

**Standby condition:** The module receives polling from the control panel at the regular interval.

**Output Operation:** On a command from the control panel the output relay will change state. It is possible to enable/disable synchronisation function for sounder/beacon devices.

**Fault condition:** The module reports to the control panel on an open or short circuit, relay stuck, PSU Fault, or drop in PSU Voltage.

**SCI in active condition:** When SCI is activated to isolate a short circuit in the loop, the LED on the module illuminates yellow.

### Alarm Devices to be connected

Recommended alarm devices to be connected are as follows. It is recommended to use EN54-3/EN54-23 certified products.

Product Name	Part Number	Connectable Number
Xenon Beacon	F06-82550	6
StroBell Combination Alarm Bell	F06-61200	20
	F06-61023	28
	F06-61024	
Excel Lite Xenon Red Sounder D/B	F06-82515	5
Excel Lite Xenon Red Sounder	F06-82510	4
Banshee EXCEL Sounder	F06-82520	7
	F06-82525	

### Disable Setting of Synchronization Function

Synchronisation is supported for StroBell Combination with periodic restart by the sounder circuit of EV-SCM2 (-EU) (Note: The other models listed above do not support synchronisation function).

If connecting devices other than those listed above and they do not operate properly, disable the synchronisation function with the DIP switch of EV-SCM2 (-EU) (refer to Table 1).

### Interchangeability with Existing Products

It is necessary to update the firmware of the control panel to respond to EV-SCM2, prior to the replacement of the existing model EV-SCM. The EOL resistors will also need to be changed.

### SCI Function

The EV-SCM2 (-EU) has a built-in short circuit isolator. The SCI circuit prevents entire loop failure in the event of a short between L+ and L- on the loop. If a short circuit is detected, the section of line containing a short circuit is automatically isolated. If not required the isolator can be bypassed using the Jumper provided.